

Flat lock Serise - MS104C-2-1G

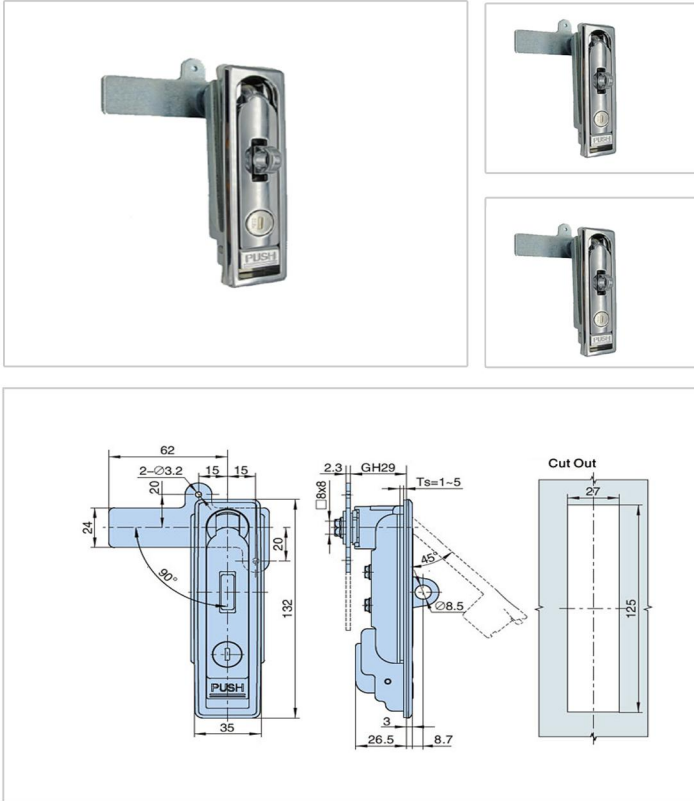

► Features :

- Material:zinc alloy for the housing, lock back,steel cam assemble ing plate .
- Panel thickness:1~5mm fixin parts
- Remark:cam cutout 8x8
- Finish:Cray chrome plating,bright chrome plating black powder coated

► Meterial :

- Zinc alloy

► Surface treatment

- Plastic Spray
- Electroplate

► Product Specification

Product No		Weight	Lot
K0600(A)	K0200		
MS104C-2-A1G	MS104C-2-1G	416.7	50

Manufacturer & Importer

Panel Door Lock / Panel Door Hinges / Latches / Door Handles / Blind Rivet Nut / Mono-Bolt Rivets
 Self Clinching Fasteners / Door gaskets / Fan Filters / Drawer Sliding Chanel